

FEATURES
22W Constant Current LED Driver
LXLCT022Series

- Input Voltage 120Vac (+/-10%)
- Total Power 22W
- Class II Output
- 5 year warranty
- UL 8750
- IP20 For Damp location
- Triac dimming option

SPECIFICATIONS

Model #	Output Current ±5%	Output Voltage Range	OCV	Remote mounting distance (#18 AWG)	Efficiency (Typ.)
					120VAC
LXLCT022S022SS-20	220mA	33-100V	110V	174 ft	82%
LXLCT022S030SS-20	300mA	24-73V	80V	128 ft	82%
LXLCT022S035SS-20	350mA	21-63V	70V	109 ft	82%
LXLCT022S040SS-20	400mA	18-54V	60V	96 ft	82%
LXLCT022S050SS-20	500mA	10-40V	45V	76 ft	82%
LXLCT022S060SS-20	600mA	10-36V	40V	64 ft	82%
LXLCT022S070SS-20	700mA	10-32V	36V	54 ft	81%
LXLCT022S080SS-20	800mA	10-28V	32V	48 ft	81%
LXLCT022S090SS-20	900mA	6-24V	28V	42 ft	81%
LXLCT022S100SS-20	1000mA	6-22V	26V	38 ft	81%
LXLCT022S110SS-20	1100mA	6-20V	24V	34 ft	81%
LXLCT022S120SS-20	1200mA	6-19V	23V	32 ft	81%

Output	Voltage Tolerance	±5% at full load condition
	Line Regulation	±1%
	Load Regulation	±2%
	No Load power Consumption	<1W
	Over Shoot	<10% at full load condition
	Ripple Noise	<10% (pk-pk)
	Turn-on Delay Time	<.75s at full load condition
	Leakage Current	Maximum 0.5mA at 120Vac, 60Hz Input
Input	Voltage Range	120Vac ±10%
	Frequency Range	60Hz
	Inrush Current	7A @ 120V
	Power Factor	>0.9 under 120Vac input with 80~100% load condition(for all output voltage)
	AC Current (Max.)	0.25A @120V
	THD	<20% under 120Vac input with 80~100% load condition(for all output voltage)
Protections	Short Circuit Protection	Hiccup mode. Protection will trigger when short circuit and will auto recover after the fault mode is removed.
	Over Current Protection	Hiccup mode. Protection will trigger when load current exceed specified output current and will auto recover after the fault mode is removed.
	Over Voltage	Hiccup mode. Protection will trigger when load voltage exceed specified output voltage and will auto recover after the fault mode is removed.
	Withstand Voltage	Input to Output, 2,800Vdc, 2mA

Environmental	Temperature Range	Operational	- 40 ~ 60°C	
		Storage	- 40 ~ 85°C	
	Humidity	5 ~ 95% RH		
	Case Temperature (Max.)	90°C		
Safety & EMC	Safety Standards	UL8750 EN61347-1, EN61347-2-13		
	EMS Immunity	EN61000-3-2, FCC, 47CFR Part 15 ANSI C63.4: 2009 Class c		
Others	MTBF	376,000 hours		
	Life Time	85,000 hours at 120Vac input, 100% load and 60°C case temperature		
	Dimensions	(L*W*H) 4.80x1.50x0.96 inches & 4.29" M (L*W*H) 122x40x25 mm & 109mm M		
	Weight	0.220 kg		
	Packaging	.22kg / UNIT ; 60pcs / carton ; 2700pcs / pallet		
		Carton size	360 x 300 x 160 mm	
		Carton weight	14kg	
Case Material		Metal		

Notes:

1. Non-Class 2 output (USR & CNR).
2. Class 2 output (USR), Non- Class 2 output (CNR).
3. Class 2 output (USR & CNR).
- 4.

Mechanical Specification

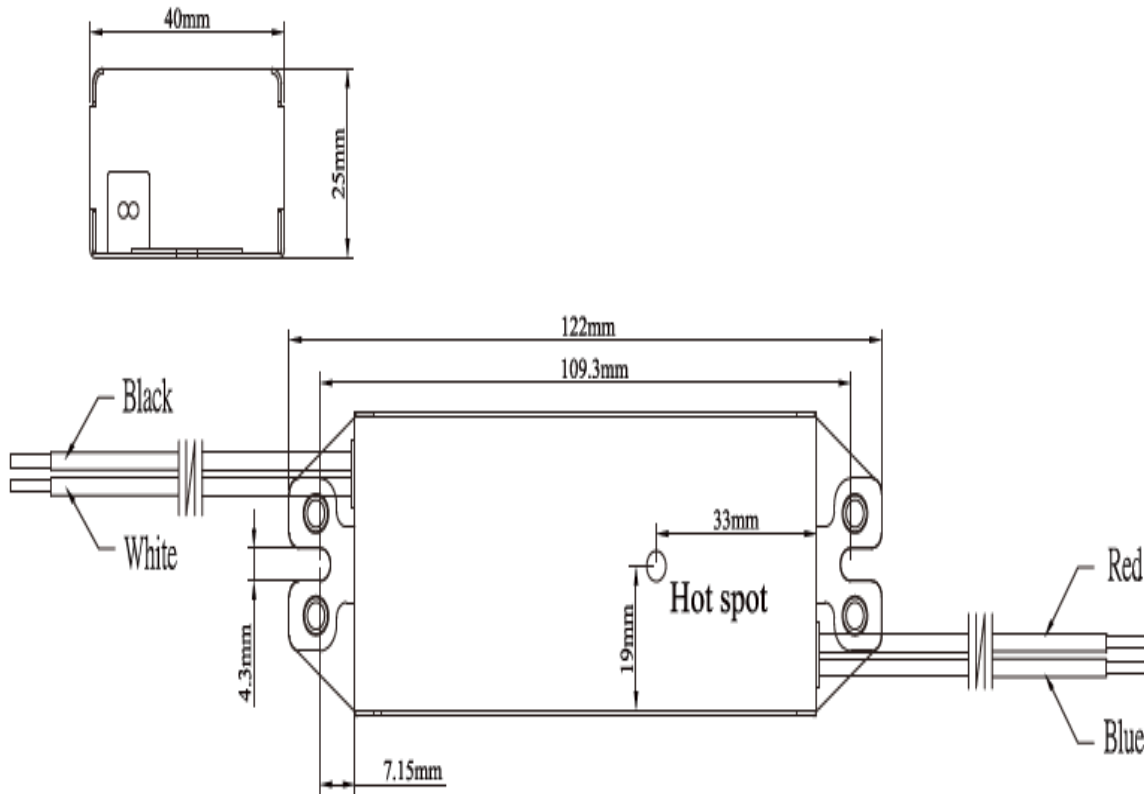

Wire Specification

Wire Specification	
Input	12", UL 1316 #18AWG (Black and White)
Output	12", UL 1316 #18AWG (Red and Blue)

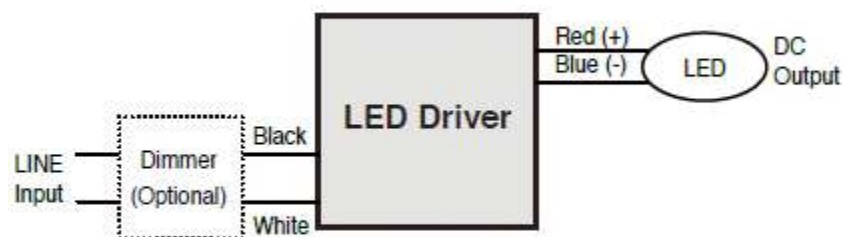

Life Time vs. Case Temperature Curve

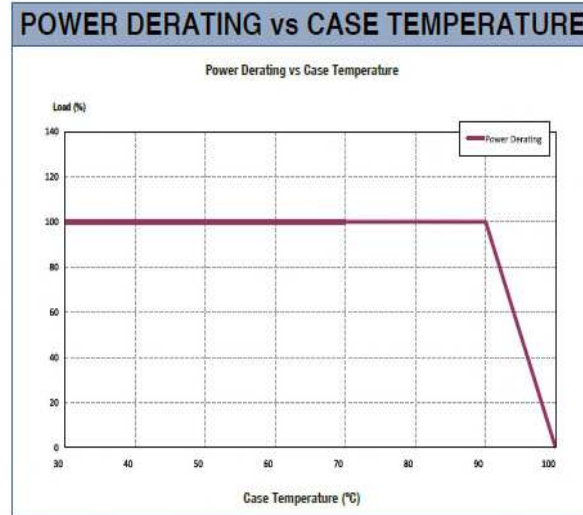
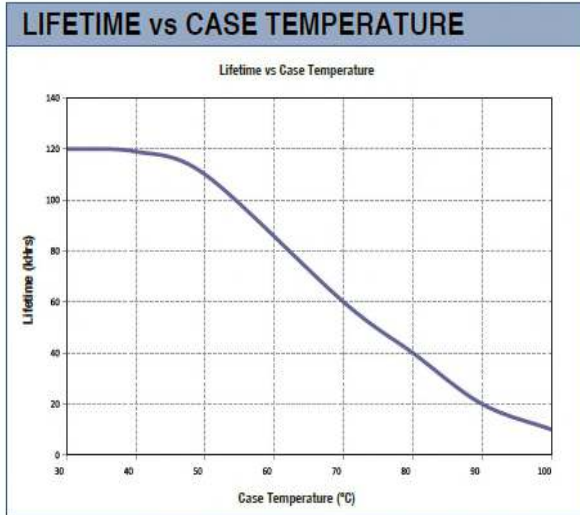

Power Factor Characters

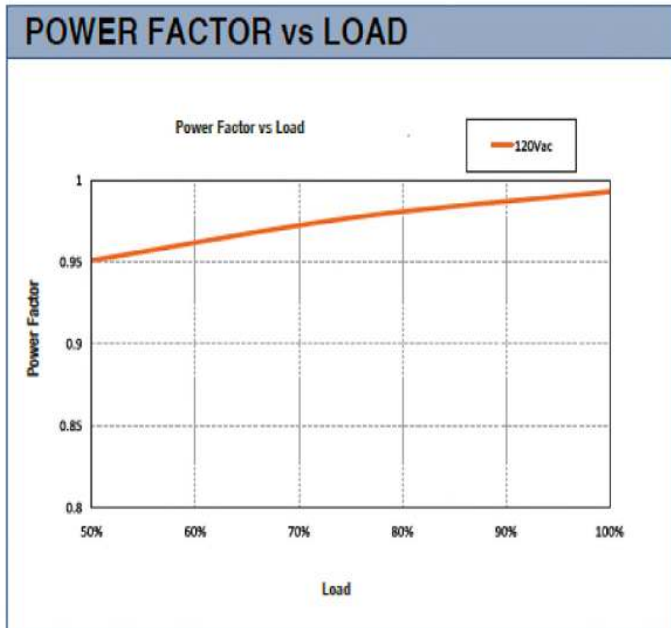

Efficiency vs Load

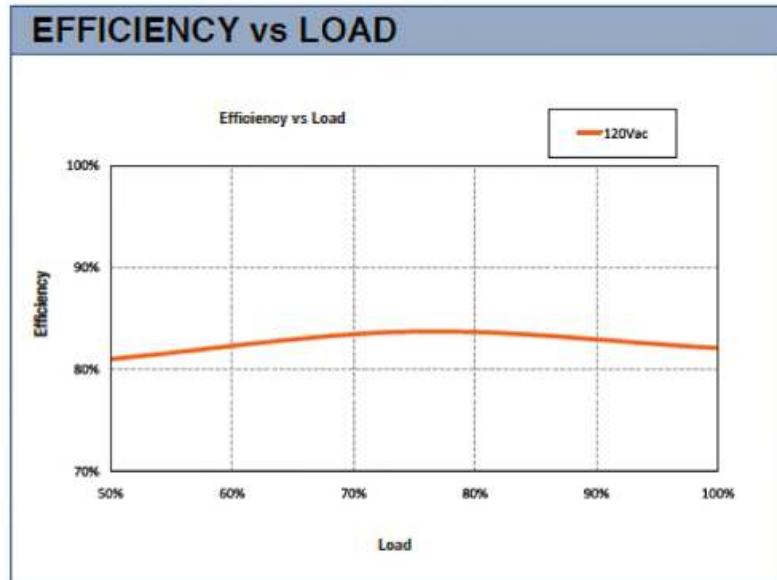

PART NUMBER SCHEME

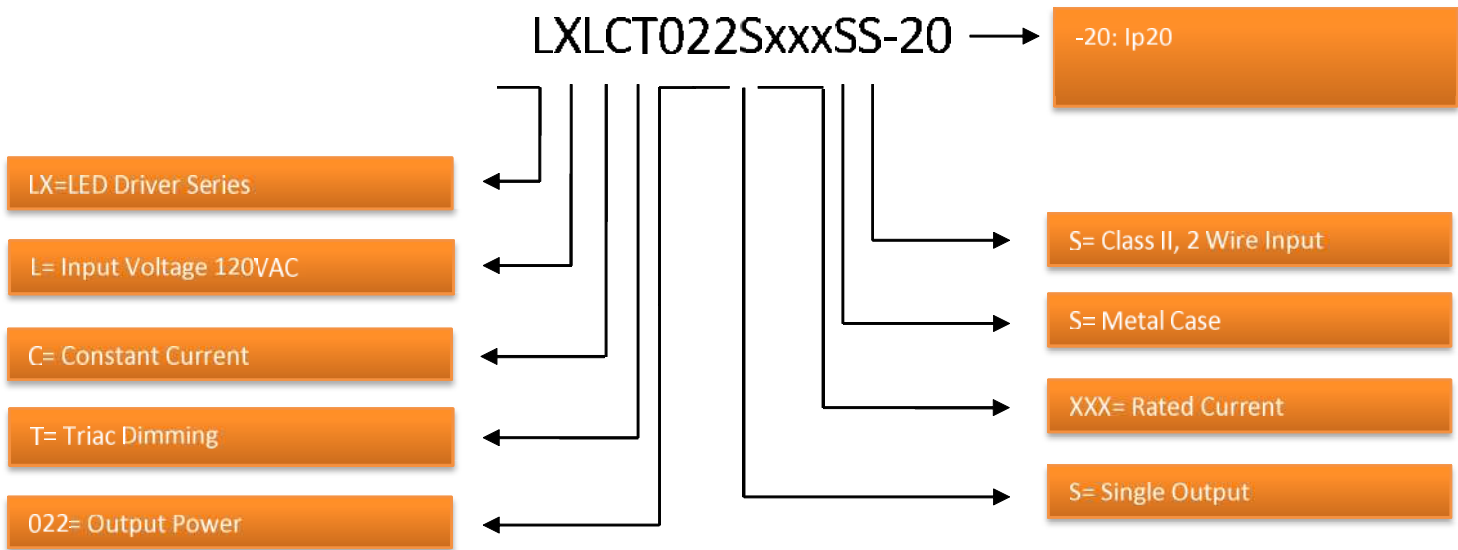

SPECIFICATIONS ARE SUBJECT TO CHANGE WITHOUT NOTICE. AUTEC IS NOT RESPONSIBLE FOR ISSUES ARISING FROM ERRORS OR OMISSIONS.