

■ Features

- Power Rating: 55W
- Input Voltage: 120-277Vac
- Constant current design
- Programmable output currents (470mA-1400mA)
- Near Field Communication Programmability
- Bluetooth module input capability
- Auxiliary power: 12Vdc, 200mA max
- Dimmable with 0-10V dimmer and down to 3% at maximum output current
- UL Class 2 Output
- OVP, SCP, OTP & Open Circuit Protection
- IP20
- 5-year warranty



*Product images are for illustrative purposes only and may vary from actual design.

■ Application

- Indoor lights

■ Model List*(See part number scheme for model number details)

Model Number	Input Voltage Range	Output Power	Output Voltage	Output Current Min.	Output Current Max.	Efficiency	Certification
LXWCP055S098ST-L	120~277Vac ± 10%	55W	28-56V	330mA	980Ma	83% @120V 84% @240V 83% @277V	UL/-
LXWCP055S140ST-L	120~277Vac ± 10%	55W	20-39V	470mA	1400mA	83% @120V 84% @240V 83% @277V	UL/cUL

■ Wiring Diagram

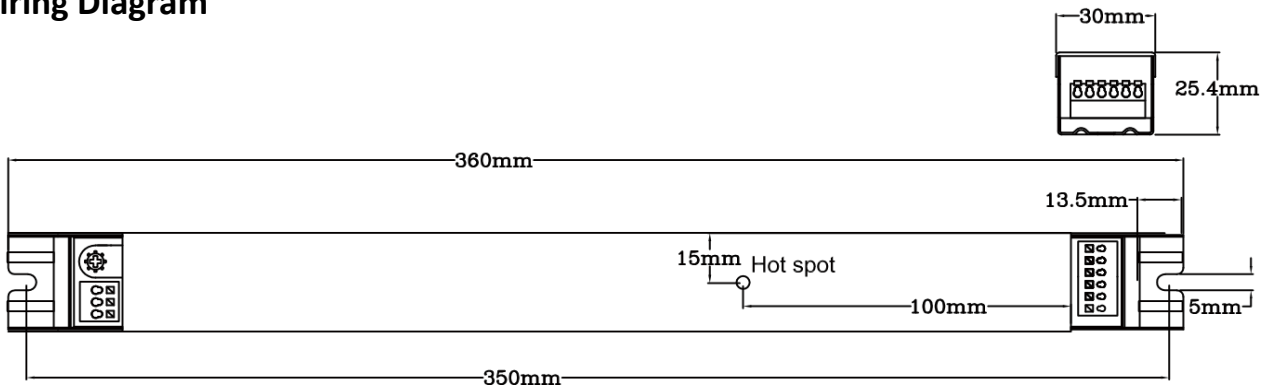

■ **Wiring Diagram(Cont.)**

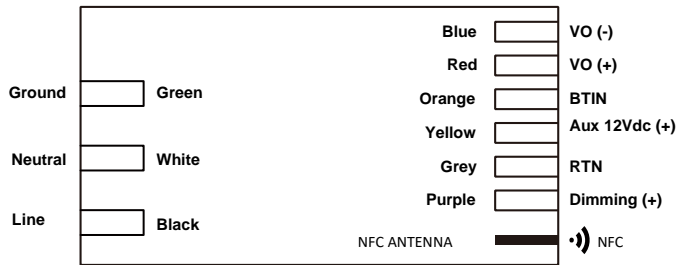

Wire Specifications	
Input	Terminal Block: (Black White and Green)
Output	Terminal Block: VO(+)(RED) and VO(-)(BLUE)
Dimming	Terminal Block: DIM(+) (PURPLE), RTN(-)(GREY), and Aux 12 Vdc (YELLOW)
Bluetooth	Terminal Block: Bluetooth module input BTIN (ORANGE)

■ **Technical Data**

Input voltage range	120~277Vac ± 10%
Frequency	50/60Hz
Power factor	> 0.9 under 120~277Vac input with 80~100% load condition (for all output currents)
Inrush current	TBD
Max input current	TBD
THD	< 20% under 120~277Vac input with 80~100% load condition (for all output currents)
Load Regulation	± 2%
Line Regulation	± 1%
Current Tolerance	± 5% at full load condition
Turn-on Delay Time	< 0.75s at full load condition
Overshoot	< 10% at full load condition
No Load Power Consumption	TBD
Ripple & Noise (pk-pk)	< 3%
Withstand voltage	Input to output, 2,800Vdc, 2mA
Leakage current	Maximum 0.5mA at 277Vac, 60Hz input
Protection	<p>Over voltage protection: Hiccup mode. Protection will trigger when load voltage exceeds specified output voltage and will auto recover after the fault mode is removed.</p> <p>Over current protection: Hiccup mode. Protection will trigger when load current exceeds specified output current and will auto recover after the fault mode is removed.</p> <p>Short circuit protection: Hiccup mode. Protection will trigger when short circuit and will auto recover after the fault mode is removed.</p> <p>Over temperature protection: Protection will trigger when driver overheat and auto-recovery when cooled down.</p>

■ **Technical Data(Cont.)**

Operating temperature	-20 to 50°C
Storage temperature	-40 to 85°C
Humidity	5% to 95%
MTBF:	TBD
Life rating	TBD
Maximum case Temperature	90°C
Length (L)	14.17" (360mm)
Width (W)	1.18" (30mm)
Height (H)	1.00" (25.4mm)
Mounting (M)	13.78" (350mm)
Packing	0.4kg/unit; 20pcs/carton; 1680pcs/pallet

■ **Safety Compliance**

UL/cUL	UL 8750 pending
CE	EN61347-1, EN61347-2-13
FCC, 47CFR Part 15	ANSI C63.4:2009 Class B (Consumer Limit)
EN61000-3-2	Harmonic Current Emissions Class C

■ **Near Field Communication Programmability**



Programming Module
REF. Part# LXWLB-PROG

NOTES:

1. The Near Field Communication programming module is used to program the output current settings.
2. The programming function is a non-contact process, which is safer and more efficient compared to traditional programming methods.
3. During programming the LED Driver does not require any external power source.
4. REF. Ordering part number LXWLB-PROG (includes programming module, USB cable, and pre-loaded software).
5. Contact Autec Sales for User Guide for complete programming instructions.

Technical Sales / Customer Service: +1-818-338-7788 • Email: sales@autec.com
31328 Via Colinas Suite 102 • Westlake Village, CA 91362 USA • www.autec.com

Power Factor vs Load

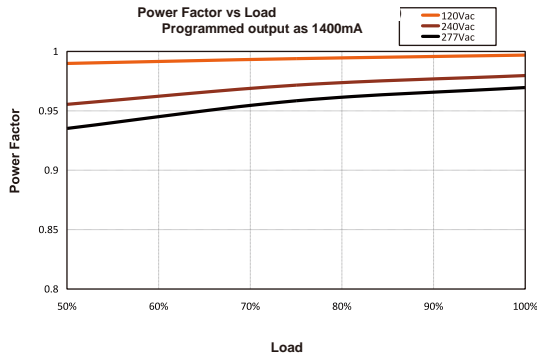

LXWCP055S140ST-L

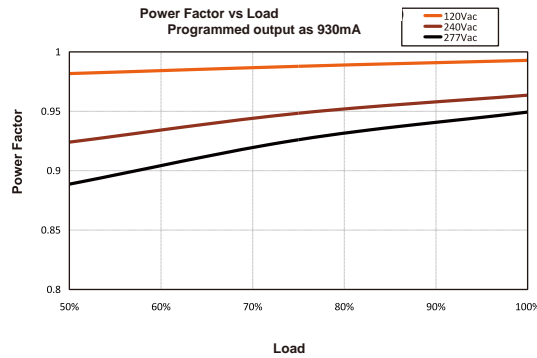
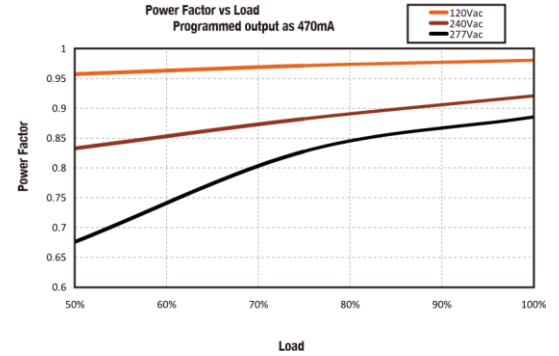

Efficiency vs Load

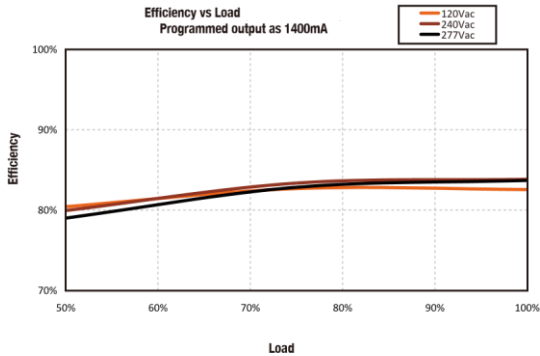

LXWCP055S140ST-L

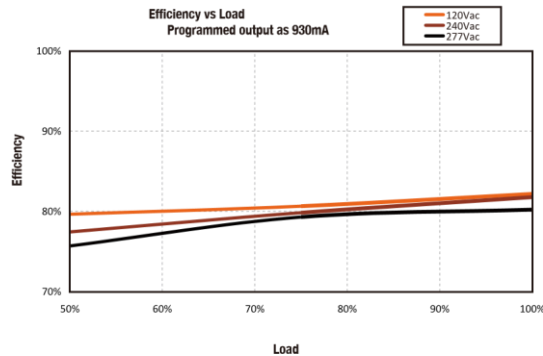
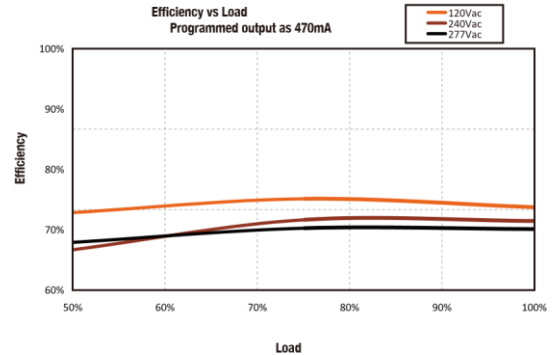

■ Lifetime vs Case Temperature

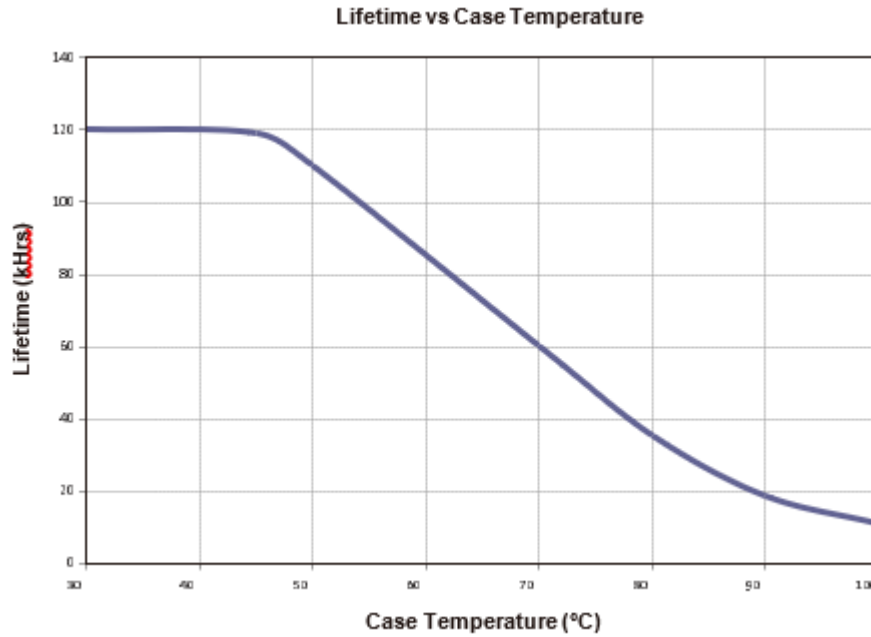

■ Power Derating Curve vs Case Temperature

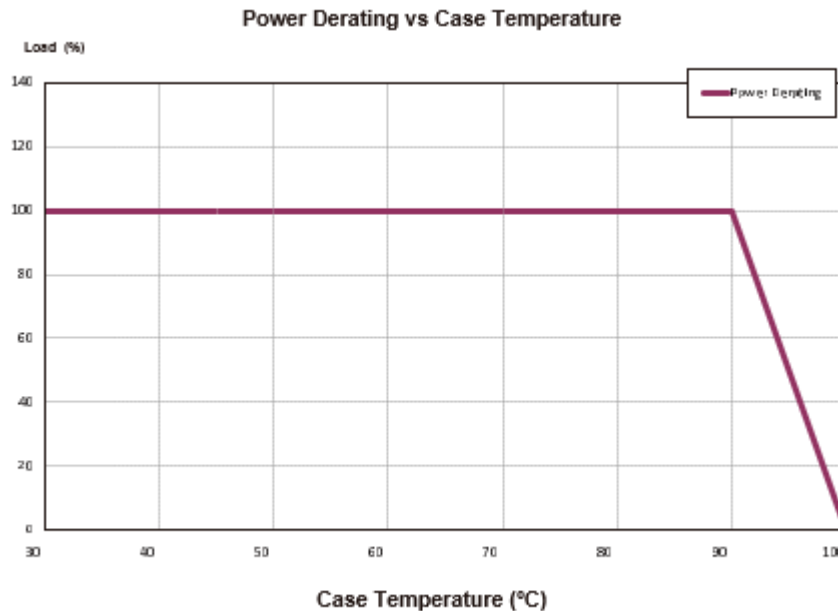

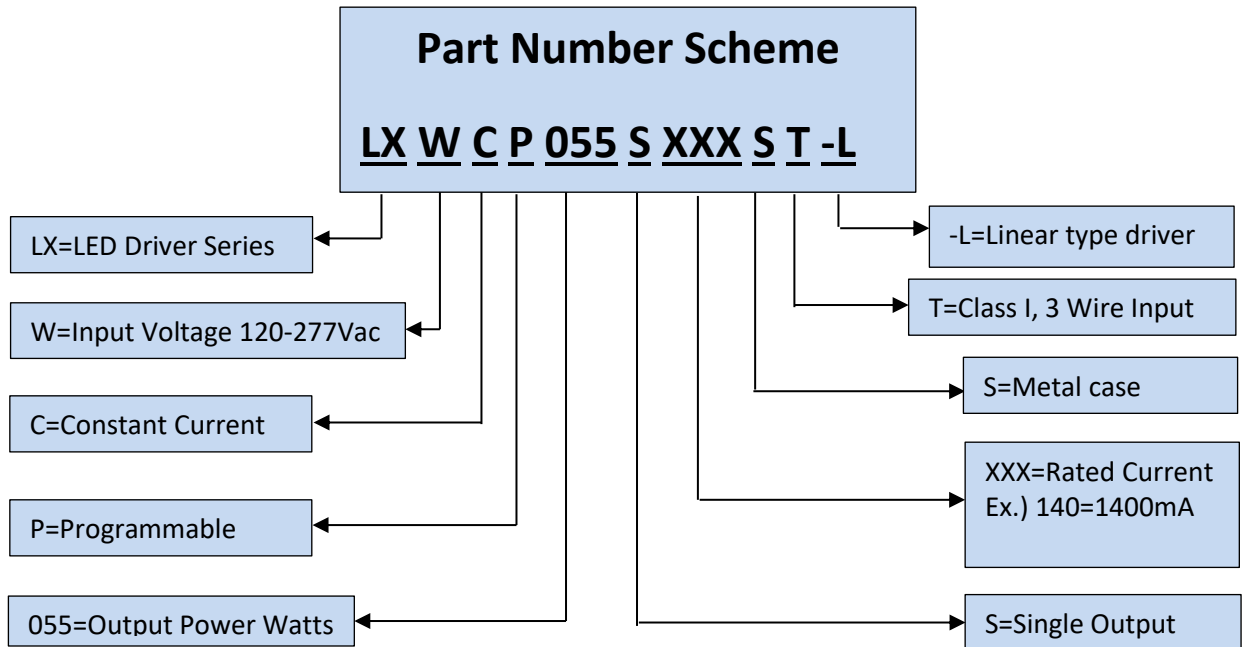

*Product images are for illustrative purposes only and may vary from actual design.

*Specifications are subject to change without notice. Autec is not Responsible for issues arising from errors or omissions.