

■ **Features**

- Power Rating: 40W
- Input Voltage: 90-305Vac
- Constant current design
- Output current(350mA-1660mA)
- Efficiency up to 91%
- Dimmable with 0-10V dimming
- UL Class 2
- OVP, OTP, SCP, PFC circuit
- IP66
- 5-year warranty
- Surge Protection: 2kV differential mode



*Product images are for illustrative purposes only and may vary from actual design.

■ **Application**

- Indoor or outdoor lights

■ **Model List***(See part number scheme for model number details)

Model Number	Input Voltage Range	Output Power	Output Voltage	Output Current Min.	Output Current Max.	Efficiency	Certification
LSWCD040S035PS	90-305Vac	40W	69-114V	350mA	350mA	89% @ 110Vac 91% @ 220Vac	UL/cUL
LSWCD040S045PS	90-305Vac	40W	53-89V	450mA	450mA	89% @ 110Vac 91% @ 220Vac	UL/cUL
LSWCD040S070PS	90-305Vac	40W	34-57V	700mA	700mA	88% @ 110Vac 90% @ 220Vac	UL/cUL
LSWCD040S105PS	90-305Vac	40W	23-38V	1050mA	1050mA	87% @ 110Vac 89% @ 220Vac	UL/cUL
LSWCD040S128PS	90-305Vac	40W	19-31V	1280mA	1280mA	86% @ 110Vac 88% @ 220Vac	UL/cUL
LSWCD040S140PS	90-305Vac	40W	17-29V	1400mA	1400mA	86% @ 110Vac 88% @ 220Vac	UL/cUL
LSWCD040S166PS	90-305Vac	40W	14-24V	1660mA	1660mA	85% @ 110Vac 87% @ 220Vac	UL/cUL

■ **Technical Data**

Input voltage range	90-305Vac
Frequency	47Hz~63Hz
Inrush current	35A cold start @230Vac
Max input current	0.43A @110Vac and 0.21A @220Vac
THD	15% Max. @277Vac
Load Regulation	3%
Line Regulation	1%
Turn-on Delay Time	1.0~2.0s (Typ)
Leakage current	0.5mA at 277Vac, 60Hz input
Protection	Over voltage protection: 1.4 Vo ±5% and will auto recover after the fault is removed. Short circuit protection: Will auto recover after the fault mode is removed. No damage shall occur to the power supply. Over temperature protection: 110°C internal temperature
Operating temperature	-35 ~ 60°C
Storage temperature	-40 ~ 85°C
Surge protection	2kV differential mode
Humidity	5% ~ 100%
MTBF	450,000 hours
Life rating:	80,000 hours
Length (L)	3.74" (95mm)
Width (W)	2.76" (70mm)
Height (H)	1.26" (32mm)

■ **Safety Compliance**

UL/cUL	UL 8750 compliance to UL1310 Class 2
EMI Radiated & Conducted	FCC Part 15 Class B
EMS Immunity	EN61000-3-2, EN61000-3-3, EN61000-4-2, EN61000-4-3, EN61000-4-4, EN61000-4-5, EN61000-4-6, EN61000-4-8, EN61000-4-11, EN61547

Technical Sales / Customer Service: +1-818-338-7788 • Email: sales@autec.com
31328 Via Colinas Suite 102 • Westlake Village, CA 91362 USA • www.autec.com

■ Wiring Diagram

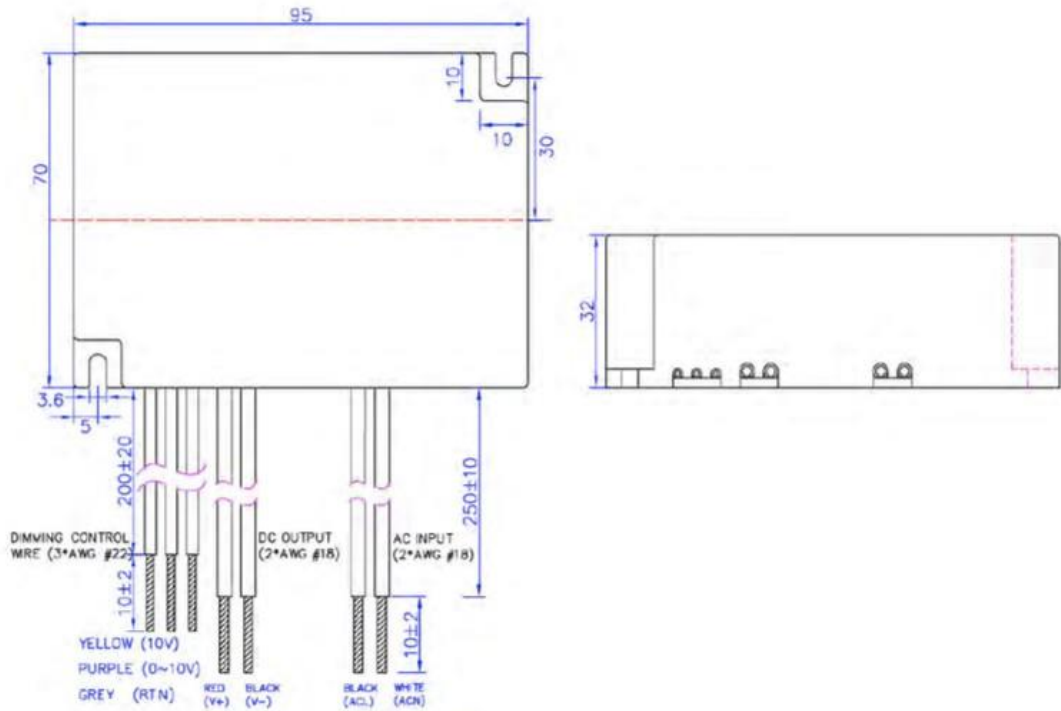

■ Derating Curves

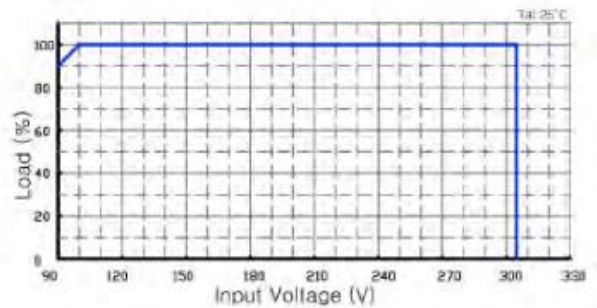
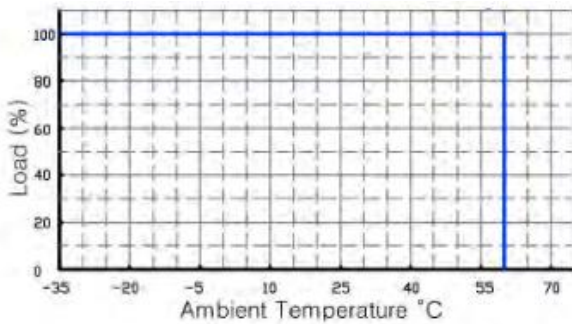

■ Dimming

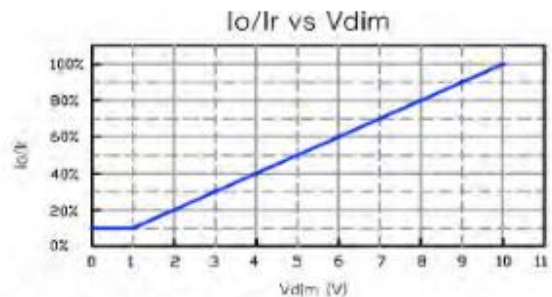
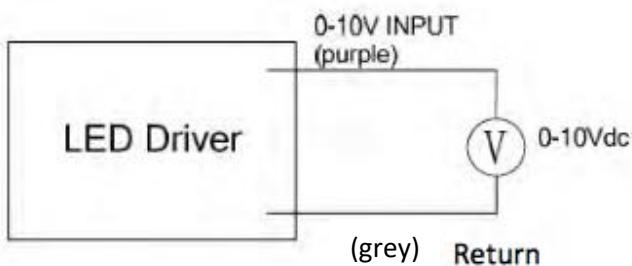

Mode 1: 0-10Vdc Input on Dimming Control

Technical Sales / Customer Service: +1-818-338-7788 • Email: sales@autec.com
31328 Via Colinas Suite 102 • Westlake Village, CA 91362 USA • www.autec.com

■ Dimming(Cont.)

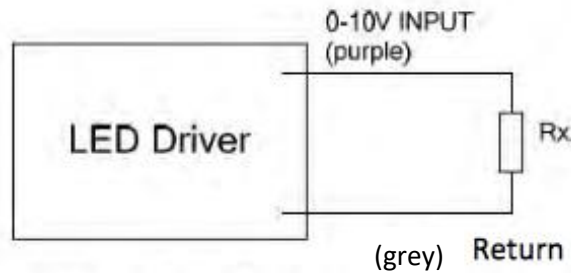

Mode 2: External Resistor on Dimming Control

Parameter	Values	Conditions
Absolute Max. Voltage	0 ~ 12 V	Normal 10~11V
0-10V Input Source Current	0 ~ 10 mA	

Note:

1. If the dimming is not used, short 10V output pin (yellow) and 1-10V input pin (purple).
2. I_o is actual output current and I_r is rated current without dimming control.
3. If the dimming signal is less than 1V the connected LEDs may flicker. Keeping dimming voltage greater than 1V in application is strongly recommended.
4. Do not connect the grey dimming wire to the output.

■ Lifetime Curves

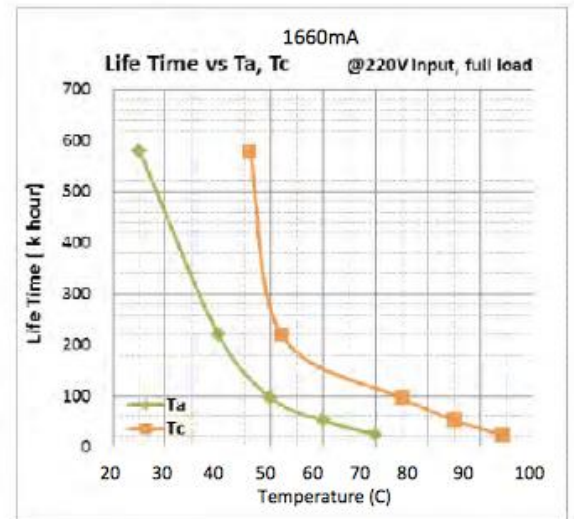
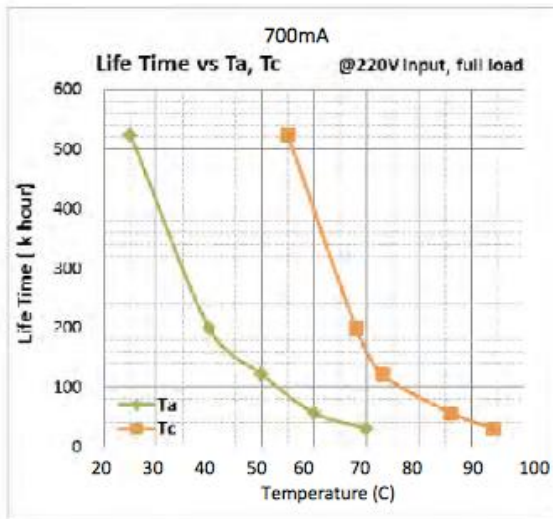

■ Power Factor Curves

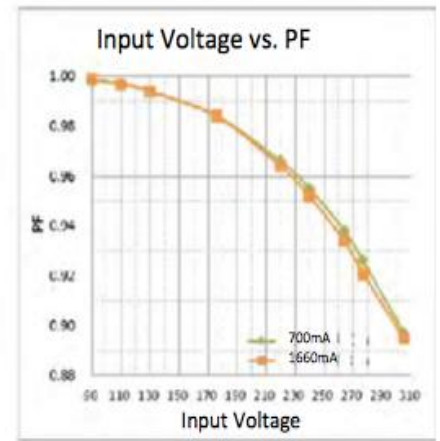
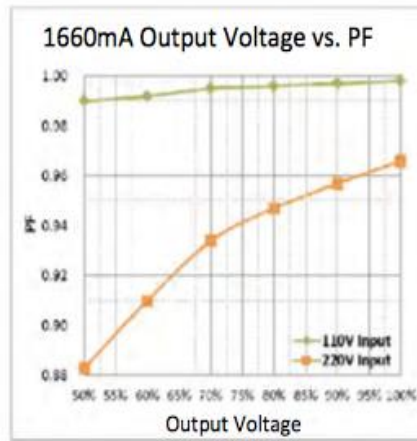
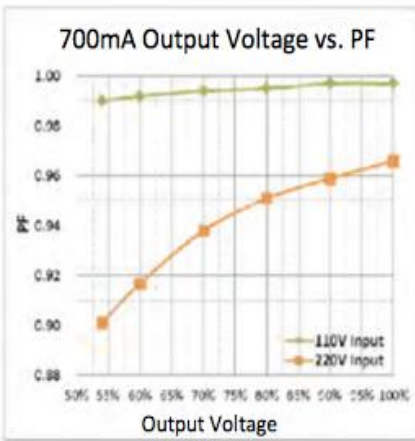

■ Efficiency Curves

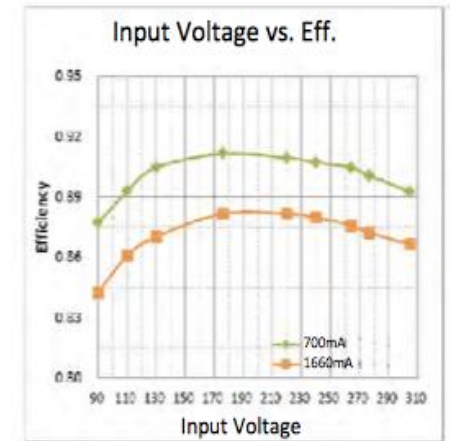
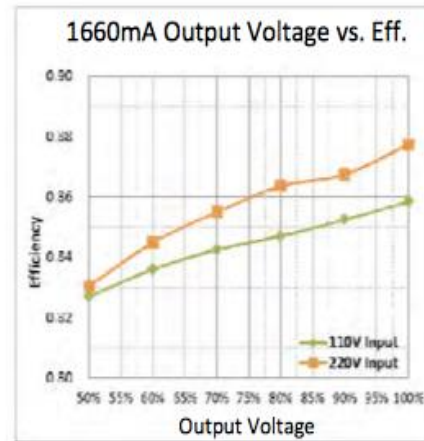
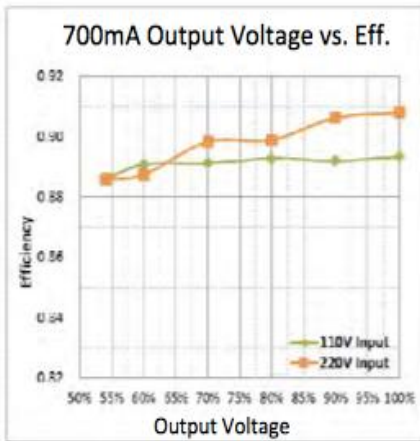

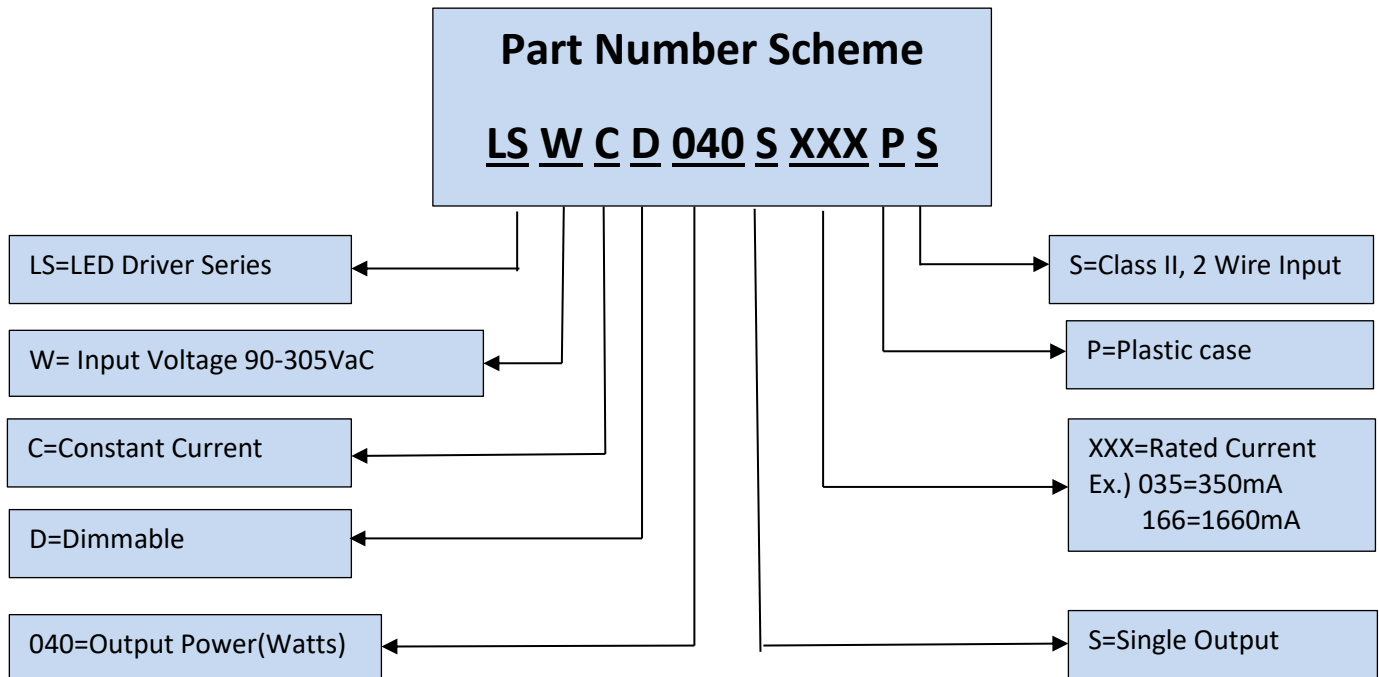

*Product images are for illustrative purposes only and may vary from actual design.

*Specifications are subject to change without notice. Autec is not responsible for issues arising from errors or omissions.