

■ Features

- Power Rating: 400W
- Input Voltage:108-305Vac
- Constant Voltage design
- Output current (0mA-166700mA)
- Efficiency up to 93%
- UL Class 2 Output
- Lightning, OVP, SCP, OTP & Open Circuit Protection
- IP67
- 7-year warranty
- Surge Protection: Line to line 5.5kV, Line to Earth 11kV

■ Application

- Outdoor and indoor LED lights
- LED lights with constant voltage
- Street lights, high bay and low bay lights, LED panels

■ Model List*(See part number scheme for model number details)

Model Number	Input Voltage Range	Output Power	Output Voltage	Output Current Min.	Output Current Max.	Efficiency	Certification
L4WV-400S024ST	108-305Vac	400W	24V	0mA	166700mA	93%	UL/cUL

■ Technical Data

Input voltage range	108-305Vac
Frequency	47-63Hz
Power factor	> 0.95 @120Vac & 80~100% Full load, > 0.90 @277Vac & 80~100% Full load
Output voltage	24V
Output power	400W
Max. Current ripple	150mVp-p
Max. Voltage ripple	±0.5%
Max input current	5.5A



*Product images are for illustrative purposes only and may vary from actual design.

■ **Technical Data(cont.)**

Max input Power	496W
Efficiency	93%
Max. open circuit voltage	N/A
THD	<20% @ 120Vac & 80~100% full load, <20% @ 277Vac & 80~100% full load
Output Current	0-166700mA
Protection	OVP, SCP, OTP, and open circuit protection
Environmental Protection	UL Dry and Damp and Wet
Working Temperature	-40~+70°C
Max Case Temperature	90°C
Surge Protection	Line to line 5kV, Line to Earth 11kV
ANSI Surge Type	1.2/50µs Combination Wave (w/t 2Ω)
Isolation (Primary to Secondary)	3750Vac/10maMax/60 seconds
Isolation (Primary to earth)	1875Vac/10maMax/60 seconds
Isolation (Secondary to Earth)	500Vac/10maMax/60 seconds
Dimension	280x123x54 mm (11.02x4.84x2.13 inch)
Mounting length	290 mm (11.42 inch)
Overall length	304 mm (11.97 inch)
Weight	3.53 kg (7.78 lb)
Lifetime	>70,000 hours @full load, 75°C Tcase
Packing	3.53 kg; 6 units/carton; 27 cartons/pallet

■ **Safety Compliance**

Safeties	UL8750
Electromagnetic Compliance	Per Title 47 CFR Part 15 Class A

■ **Derating Curve**

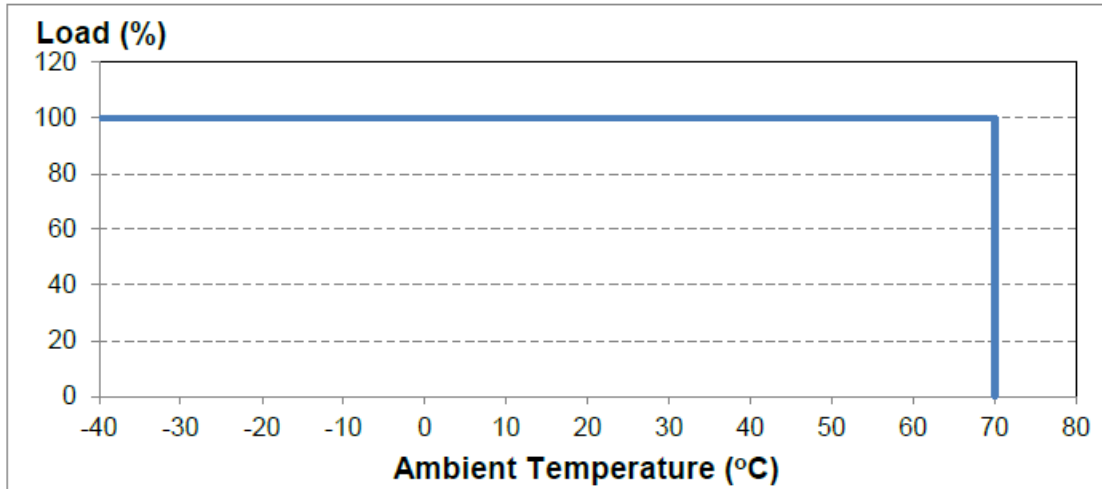

■ **Static Characteristics**

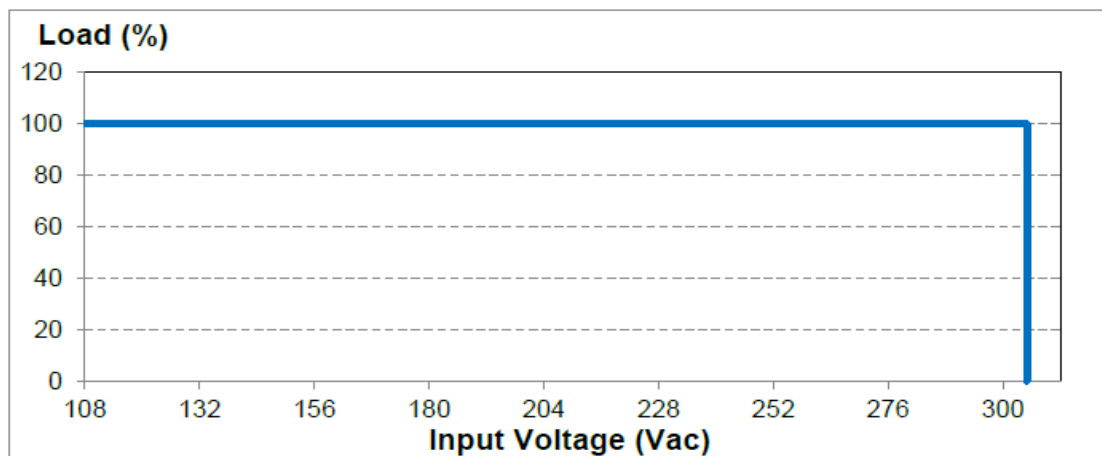

■ **Electrical Specifications**

Output Current vs. Case Temperature (with $\pm 5^\circ\text{C}$ Tolerance)

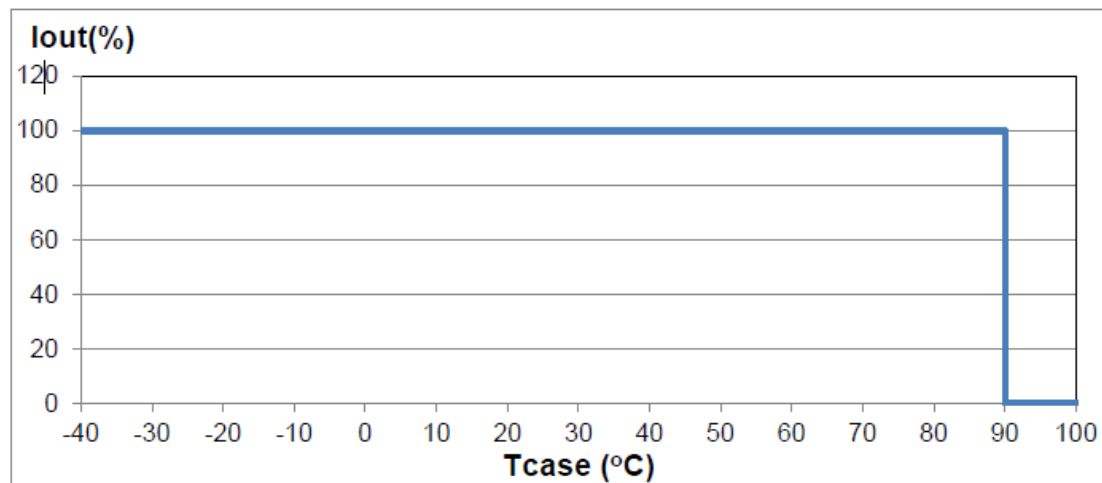

Technical Sales / Customer Service: +1-818-338-7788 • Email: sales@autec.com
 31328 Via Colinas Suite 102 • Westlake Village, CA 91362 USA • www.autec.com

■ Lifetime vs Case Temperature

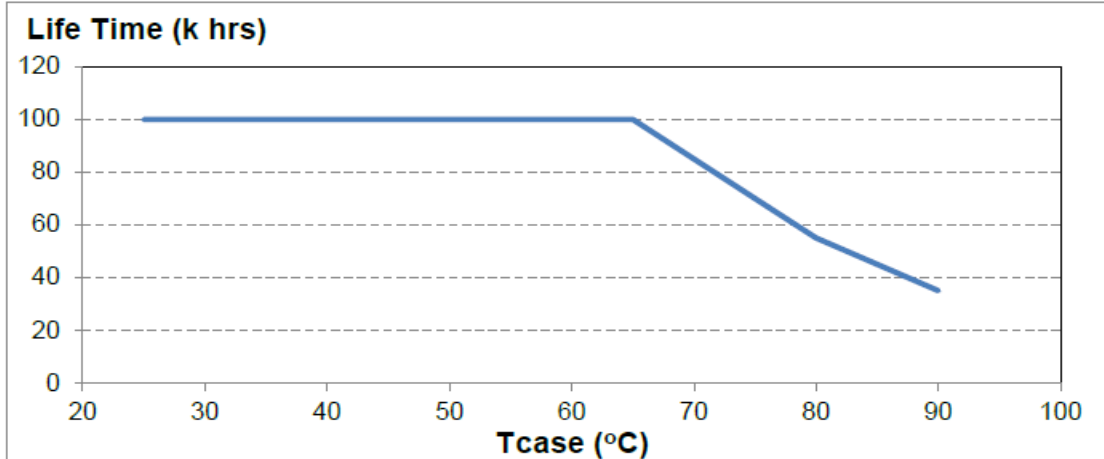

■ Power Factor vs. Output Power

(@ 25°C)

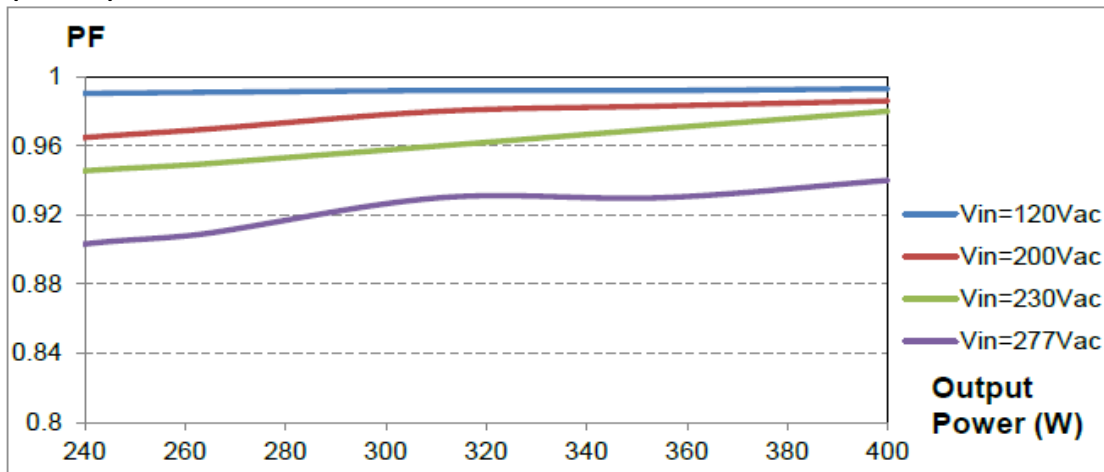

■ THD vs. Output Power

(@ 25°C)

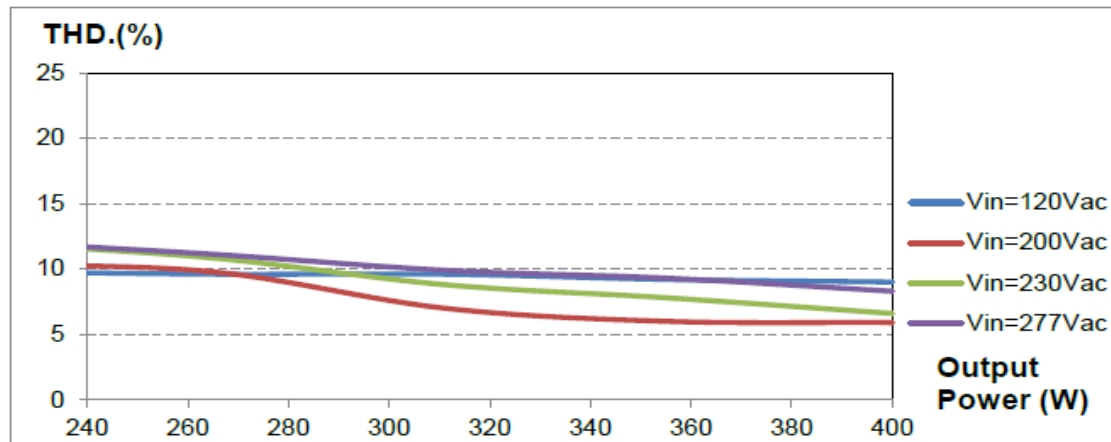

Technical Sales / Customer Service: +1-818-338-7788 • Email: sales@autec.com
31328 Via Colinas Suite 102 • Westlake Village, CA 91362 USA • www.autec.com

■ Efficiency vs. Output Power

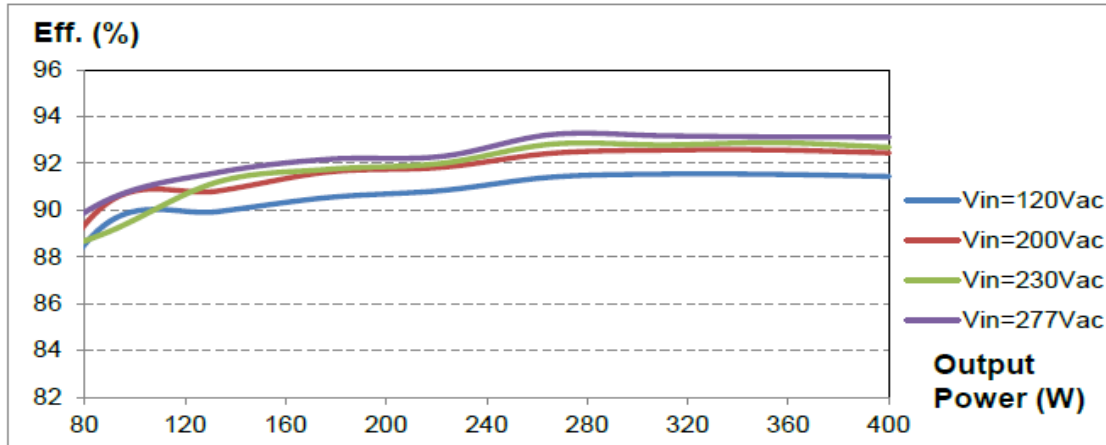

■ Mechanical Diagram

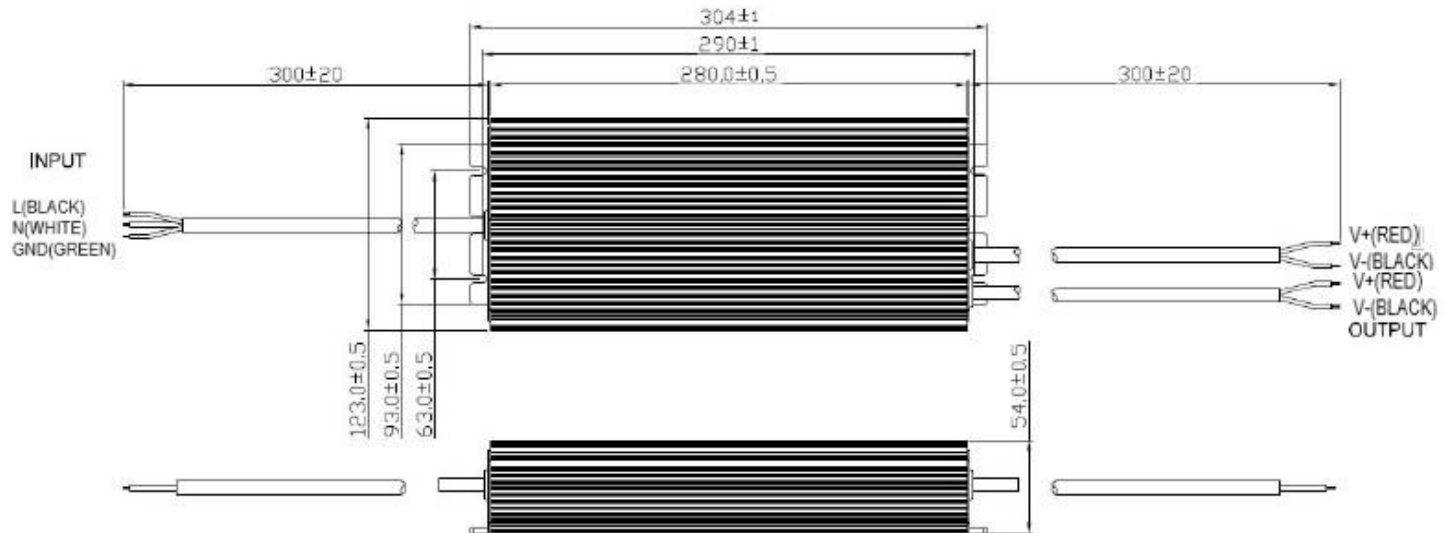

- Notes: 1. Outline Dimension: 304L*123W*54H
 2. Input and Output Connector and Pin Assignment

Input Wire	3/#18AWG	L= Black, N=White, GND=Green
Output	2/#18AWG	V+ is Red, V- is Black

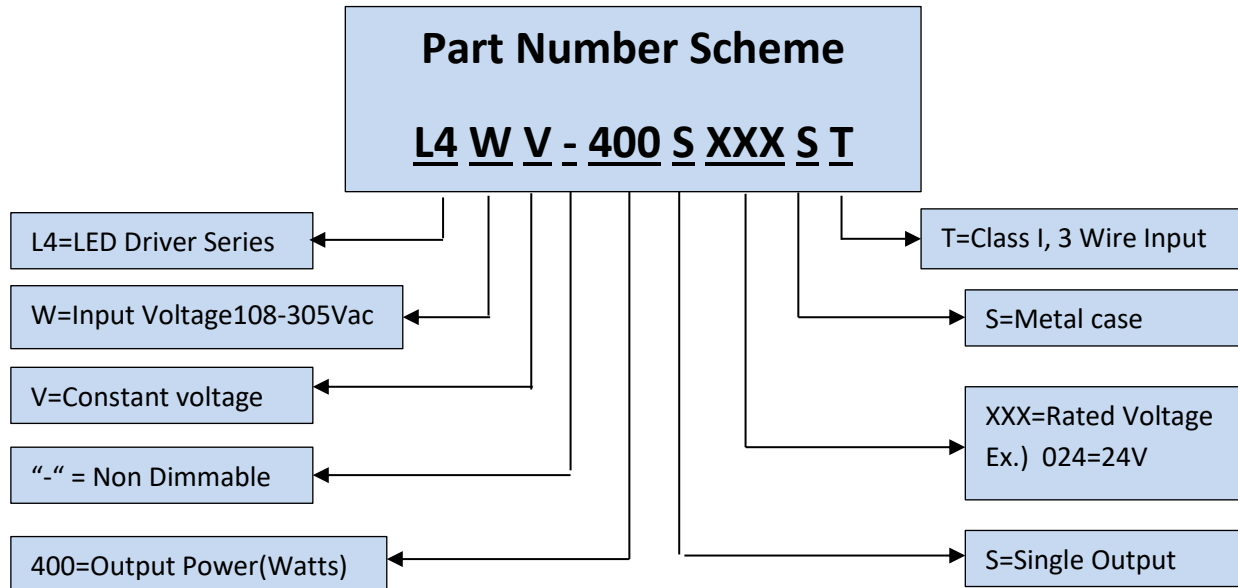

***Product images are for illustrative purposes only and may vary from actual design.**

***Specifications are subject to change without notice. Autec is not responsible for issues arising from errors or omissions.**