

FEATURES
16W Constant Current LED Driver
LXLCT016Series

- Input Voltage 120Vac (+/-10%)
- Total Power 16W
- Class II Output
- 5 year warranty
- UL 8750
- IP20 For Damp location
- Triac dimming option

SPECIFICATIONS

Model #	Output Current ±5%	Output Voltage Range	OCV	Remote mounting distance (#18 AWG)	Efficiency (Typ.)
					120VAC
LXLCT016S029SS-20	290mA	17-54V	58V	132 ft	81%
LXLCT016S030SS-20	300mA	17-53V	57V	128 ft	81%
LXLCT016S040SS-20	400mA	13-40V	44V	96 ft	81%
LXLCT016S050SS-20	500mA	10-32V	36V	76 ft	81%
LXLCT016S060SS-20	600mA	9-27V	31V	64 ft	81%
LXLCT016S070SS-20	700mA	8-23V	27V	54 ft	81%
LXLCT016S080SS-20	800mA	7-20V	24V	48 ft	81%
LXLCT016S090SS-20	900mA	6-18V	22V	42 ft	81%
LXLCT016S100SS-20	1000mA	6-16V	20V	38 ft	80%
LXLCT016S110SS-20	1100mA	6-15V	19V	34 ft	80%
LXLCT016S120SS-20	1200mA	6-13V	17V	32 ft	80%
LXLCT016S130SS-20	1300mA	6-12V	16V	29 ft	80%
LXLCT016S140SS-20	1400mA	6-11V	15V	27 ft	80%

Output	Voltage Tolerance	±5% at full load condition
	Line Regulation	±1%
	Load Regulation	±2%
	No Load power Consumption	<1W
	Over Shoot	<10% at full load condition
	Ripple Noise	<10% (pk-pk)
	Turn-on Delay Time	<.75s at full load condition
Leakage Current	Maximum 0.5mA at 120Vac, 60Hz Input	
Input	Voltage Range	120Vac ±10%
	Frequency Range	60Hz
	Inrush Current	7A @ 120V
	Power Factor	>0.9 under 120Vac input with 80~100% load condition(for all output voltage)
	AC Current (Max.)	0.18A @120V
	THD	<20% under 120Vac input with 80~100% load condition(for all output voltage)
Protections	Short Circuit Protection	Hiccup mode. Protection will trigger when short circuit and will auto recover after the fault mode is removed.
	Over Current Protection	Hiccup mode. Protection will trigger when load current exceed specified output current and will auto recover after the fault mode is removed.
	Over Voltage	Hiccup mode. Protection will trigger when load voltage exceed specified output voltage and will auto recover after the fault mode is removed.
	Withstand Voltage	Input to Output, 2,800Vdc, 2mA

Environmental	Temperature Range	Operational	- 40 ~ 60°C	
		Storage	- 40 ~ 85°C	
	Humidity	5 ~ 95% RH		
	Case Temperature (Max.)	90°C		
Safety & EMC	Safety Standards	UL8750 EN61347-1, EN61347-2-13		
	EMS Immunity	EN61000-3-2, FCC, 47CFR Part 15 ANSI C63.4: 2009 Class c		
Others	MTBF	376,000 hours		
	Life Time	85,000 hours at 120Vac input, 100% load and 60°C case temperature		
	Dimensions	(L*W*H) 4.80x1.58x0.96 inches & 4.29" M (L*W*H) 122x40x25 mm & 109mm M		
	Weight	0.220 kg		
	Packaging	.22kg / UNIT ; 60pcs / carton ; 2700pcs / pallet		
		Carton size	360 x 300 x 160 mm	
Carton weight		14kg		
Case Material		Metal		

Notes:

1. Non-Class 2 output (USR & CNR).
2. Class 2 output (USR), Non- Class 2 output (CNR).
3. Class 2 output (USR & CNR).

Mechanical Specification

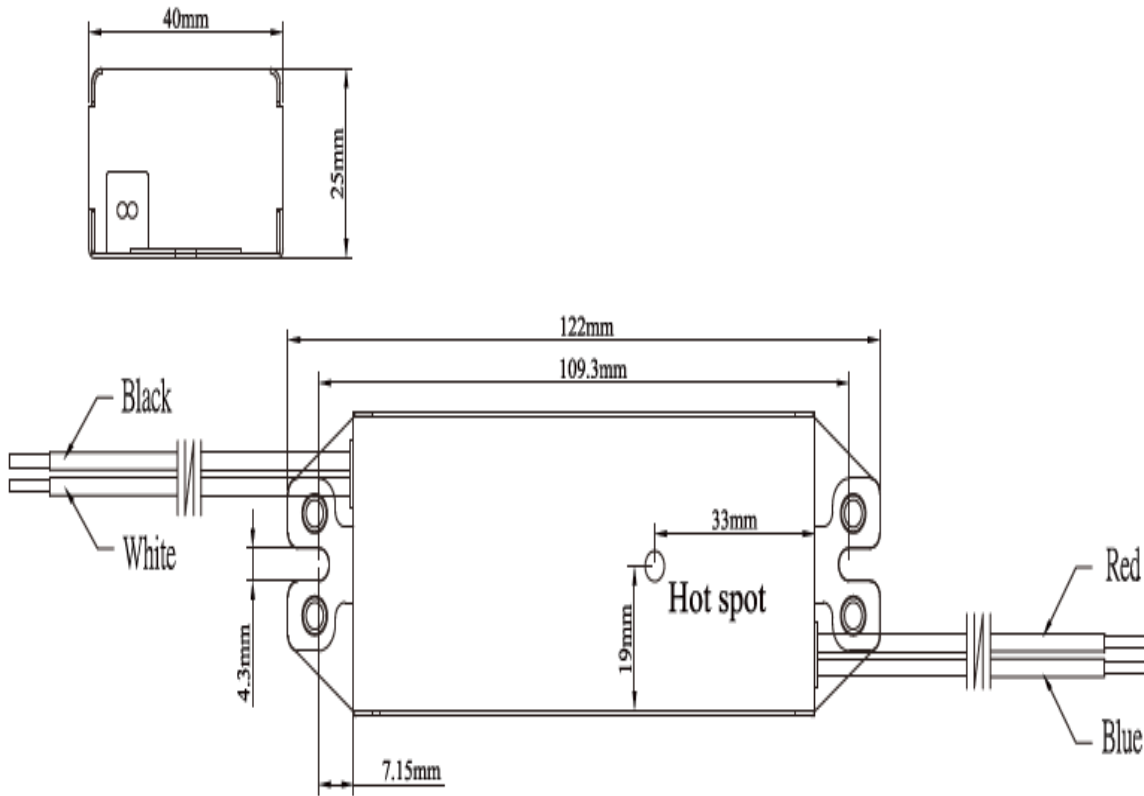

Wire Specification

Wire Specification	
Input	12", UL 1316 #18AWG (Black and White)
Output	12", UL 1316 #18AWG (Red and Blue)

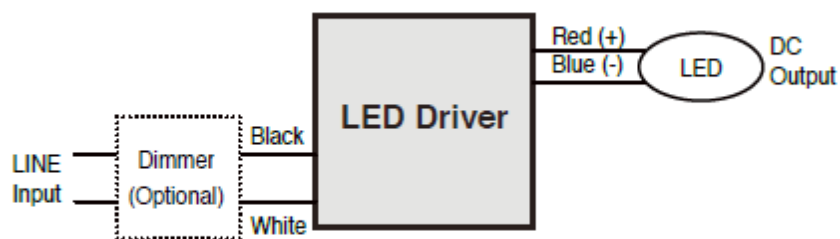

Life Time vs. Case Temperature Curve

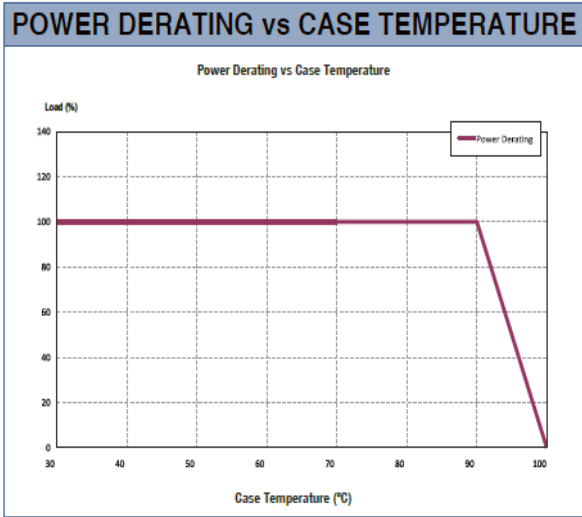
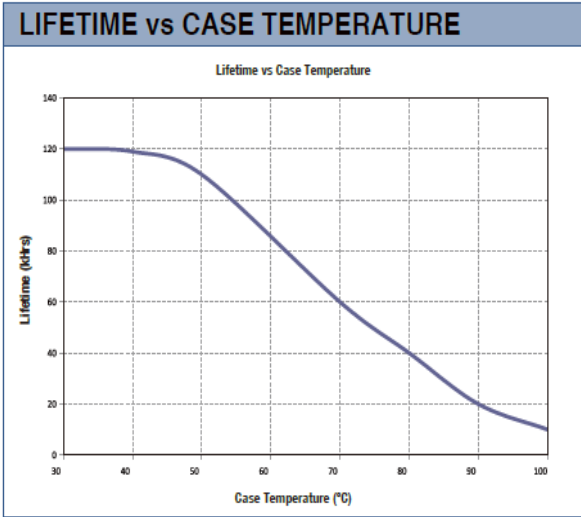

Power Factor Characters

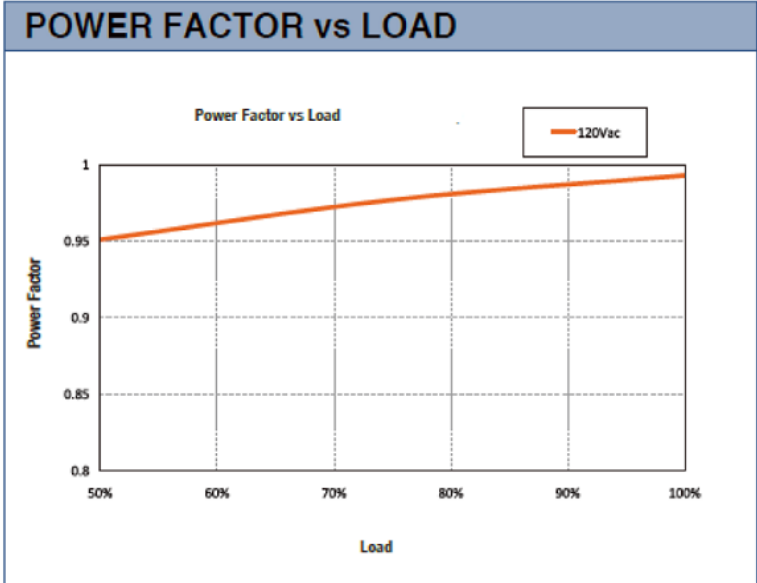

Efficiency vs Load

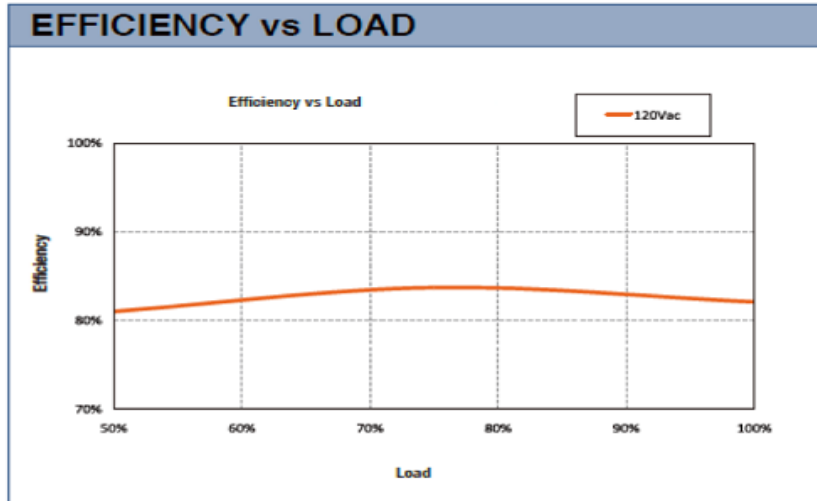

PART NUMBER SCHEME

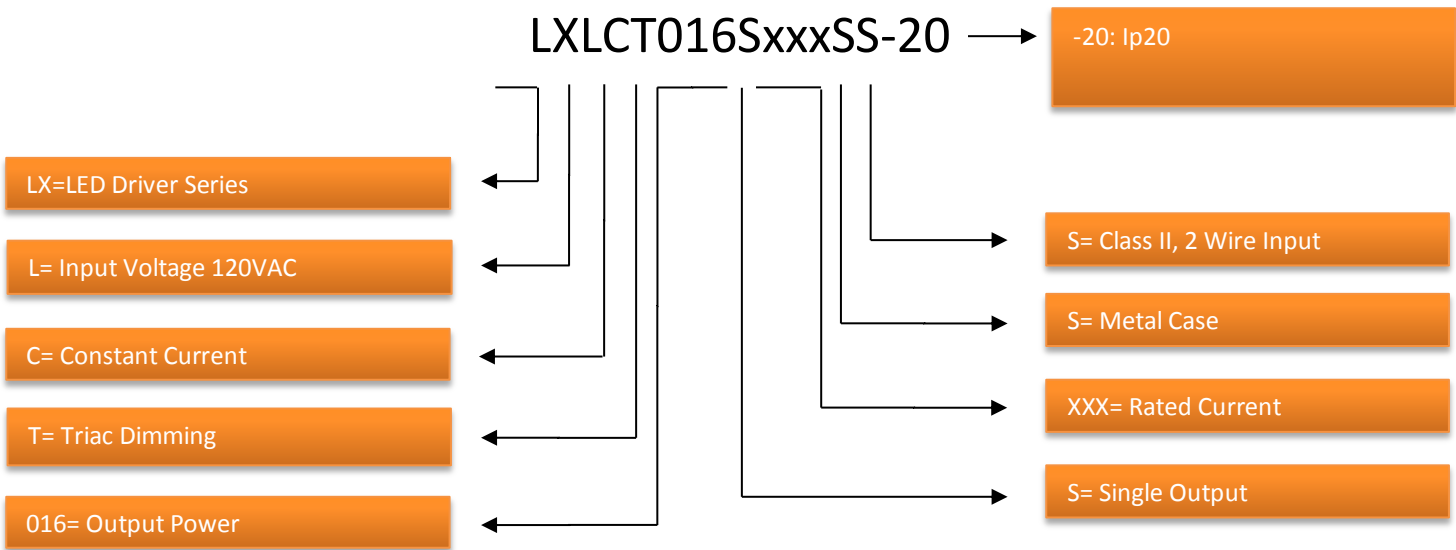

SPECIFICATIONS ARE SUBJECT TO CHANGE WITHOUT NOTICE. AUTEC IS NOT RESPONSIBLE FOR ISSUES ARISING FROM ERRORS OR OMISSIONS