



5

Item	Quantity	Unit	Price	Total	Notes
...	...	...	...	...	...
...	...	...	...	...	...
...	...	...	...	...	...

...	...	...
	...	...
	...	...
	...	...
	...	...
	...	...
	...	...
	...	...
...	...	...
	...	...
	...	...
	...	...
	...	...
...	...	...
	...	...
	...	...
	...	...

Environmental	Temperature Range	Operational	- 40 ~ 60°C	
		Storage	- 40 ~ 85°C	
	Humidity	5 ~ 95% RH		
	Case Temperature (Max.)	90°C		
Safety & EMC	Safety Standards	UL8750 P EN61347-1, EN61347-2-13		
	EMS Immunity	EN61000-3-2, FCC, 47CFR Part 15 ANSI C63.4: 2009 Class c		
Others	MTBF	440,000 hours		
	Life Time	76,000 hours at 120Vac input, 100% load and 60°C case temperature		
	Dimensions	(L*W*H) 9.57 *1.13*1.07 inches & 8.95" M (L*W*H) 243*29.5*27.5 mm & 227.7mm M		
	Weight	0.400 kg		
	Packaging			.40kg / UNIT ; 50pcs / carton ; 1750pcs / pallet
		Carton size	430 x 300 x 160 mm	
Carton weight		20kg		
Case Material		Metal		

Notes:

1. Non-Class 2 output (USR & CNR).
2. Class 2 output (USR), Non- Class 2 output (CNR).
3. Class 2 output (USR & CNR).

**Mechanical Specification**

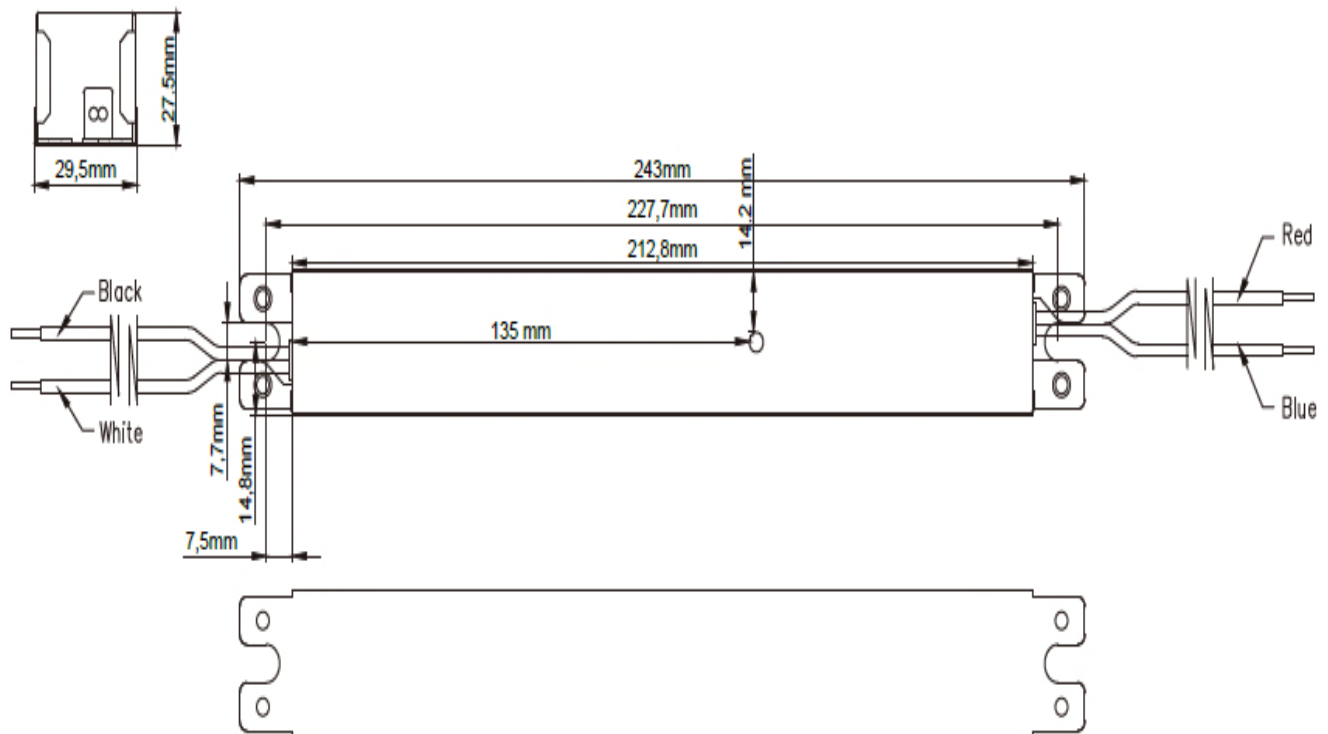

Wire Specification

Wire Specification	
<b>Input</b>	12", UL 1316 #18AWG (Black and White)
<b>Output</b>	12", UL 1316 #22AWG (Red and Blue)

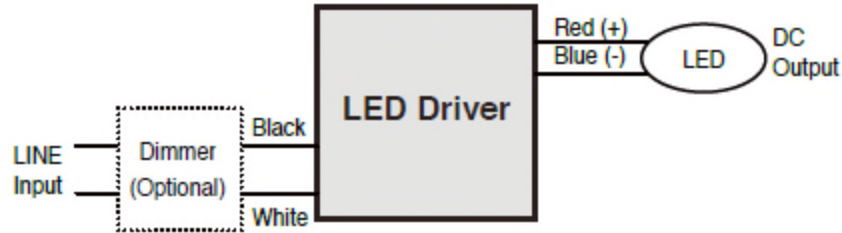

Life Time vs. Case Temperature Curve

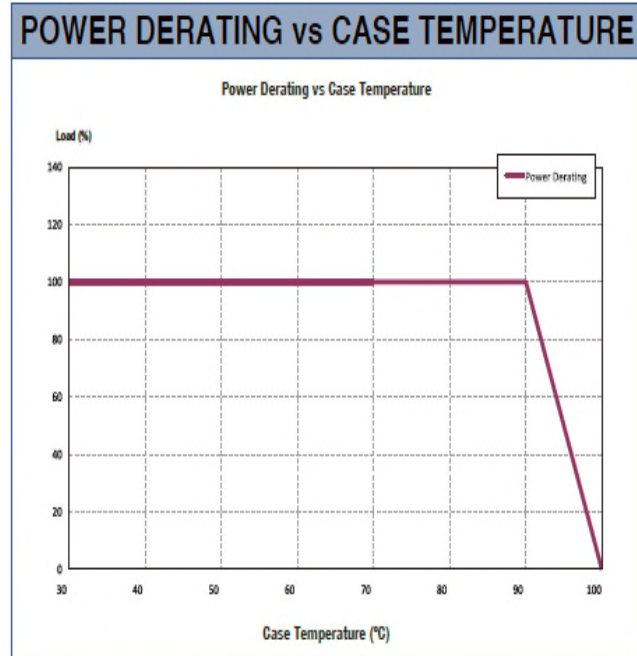
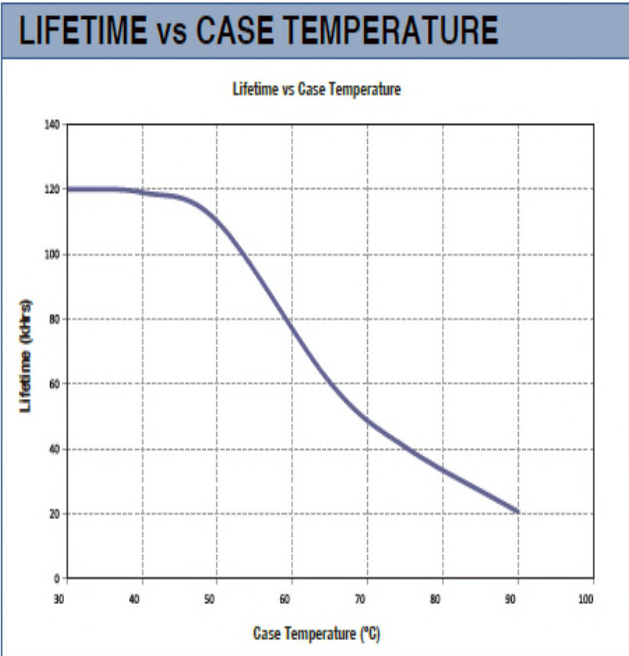

Power Factor Characters

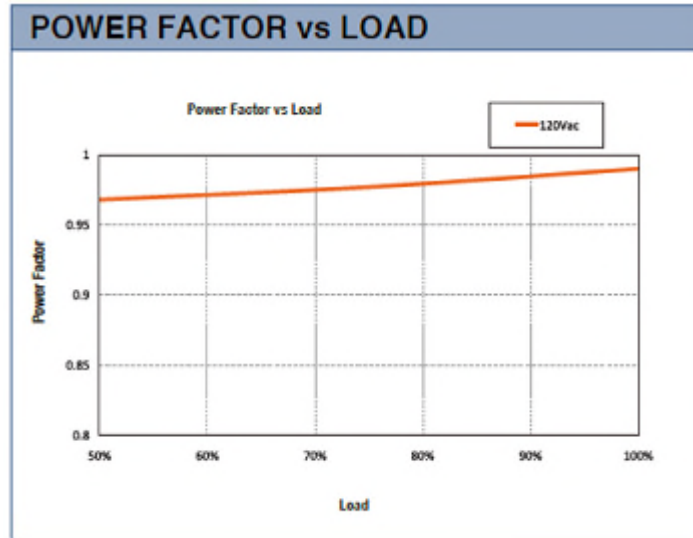

Efficiency vs Load

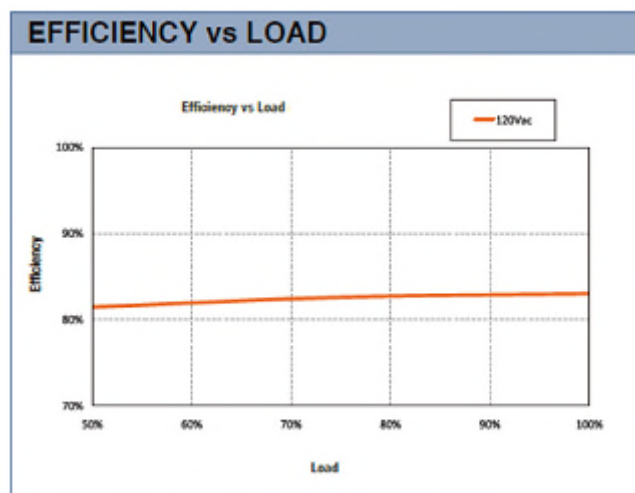

**PART NUMBER SCHEME**

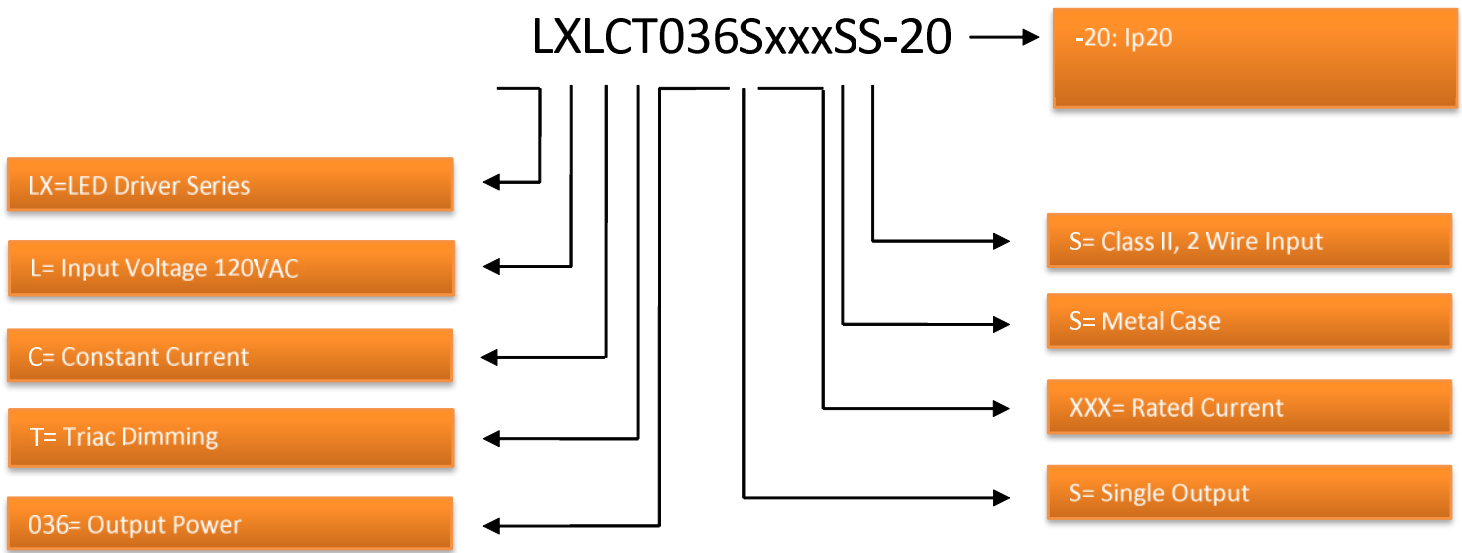

SPECIFICATIONS ARE SUBJECT TO CHANGE WITHOUT NOTICE. AUTEC IS NOT RESPONSIBLE FOR ISSUES ARISING FROM ERRORS OR OMISSIONS.